



EVENLITE
LIVES DEPEND ON US

Contractors Guide

Central Inverter System Installation

Step By Step Procedures – 3,000 Watt/VA
Vertical (Stacked) and Horizontal (Side by Side)

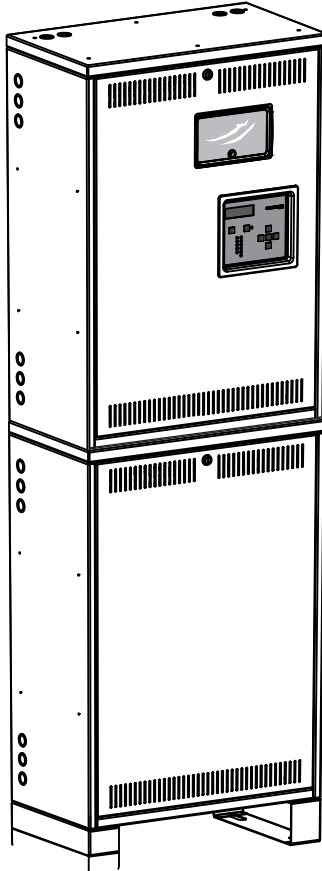

5 Step Installation

1. Mounting the Cabinet
2. Install / Connect Batteries
3. Install Conduit
4. Install AC Wiring
5. Energize System

Inverter shown is 3KW using a Stacked(Vertical) configuration. (Factory preferred configuration)

Note - Remove Floor Mounting Brackets from Inverter Cabinet for Vertical Mounting configuration

For additional information, please refer to the Installation/Operation Manual

Technical Support / Installation Questions - Call 1-800-967-5573

Monday-Friday, 8AM-5PM EST

2575 Metropolitan Drive • Trevoose • PA 19053 U•S•A

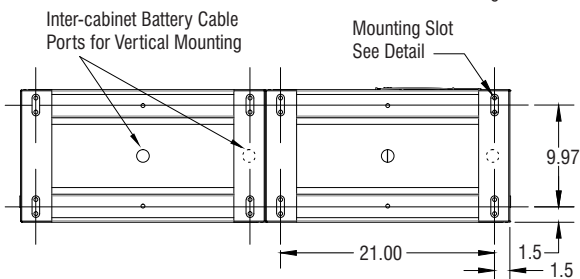
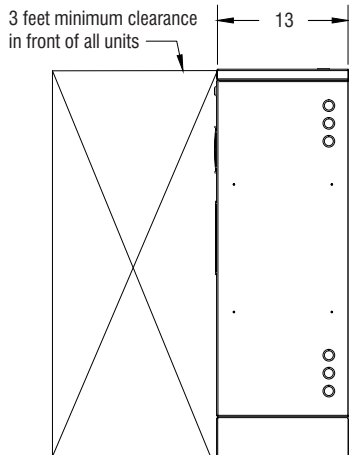
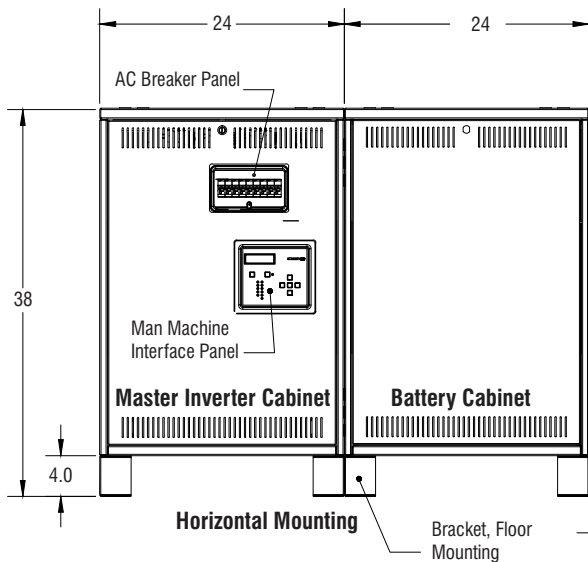

Floor Mounting Bolt Pattern

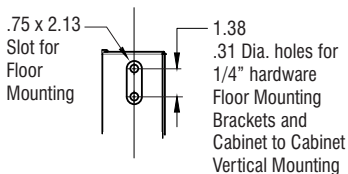

Mounting Slot Detail

**Horizontal (Side by Side)
Battery Cabinet mounted to the right side of Electronics Cabinet for proper battery cable routing from cabinet to cabinet**

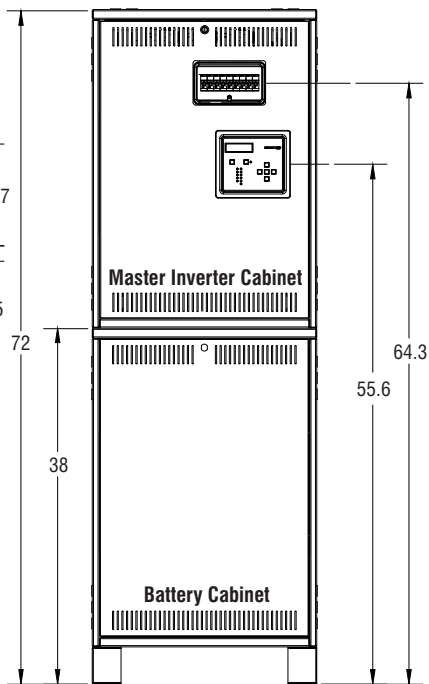

Vertical Mounting

**Vertical (Stacked)
Battery Cabinet mounted underneath Electronics Cabinet for proper battery cable routing from cabinet to cabinet**

Overall Mechanical Dimensions

Technical Support / Installation Questions - Call 1-800-967-5573

Monday-Friday, 8AM-5PM EST

2575 Metropolitan Drive • Treviso • PA 19053 U•S•A

Step 1 Mounting the Cabinet

Mounting can be either **Vertical** (Stacked) or **Horizontal** (Side by Side).

Each cabinet is shipped with Floor Mounting Brackets to accommodate both configurations. Preferred method is Vertical mounting such that the Front Panel Display is at user's eye level.

For Vertical configuration, the Floor Mounting Bracket must be removed from the Inverter Cabinet. Lay Inverter Cabinet on its back or side and remove the underside mounted (8x) 1/4-20 flange bolts.

Prepare floor so that it is level and smooth and secure Battery Cabinet into floor using Concrete Wedge Anchors or other suitable method (hardware provided by others). If using Horizontal mounting, secure the Inverter cabinet to the left of the battery cabinet for proper battery cable routing from Battery Cabinet to Electronics Cabinet.

Note - Uneven surfaces may cause difficult front cover removal/installation

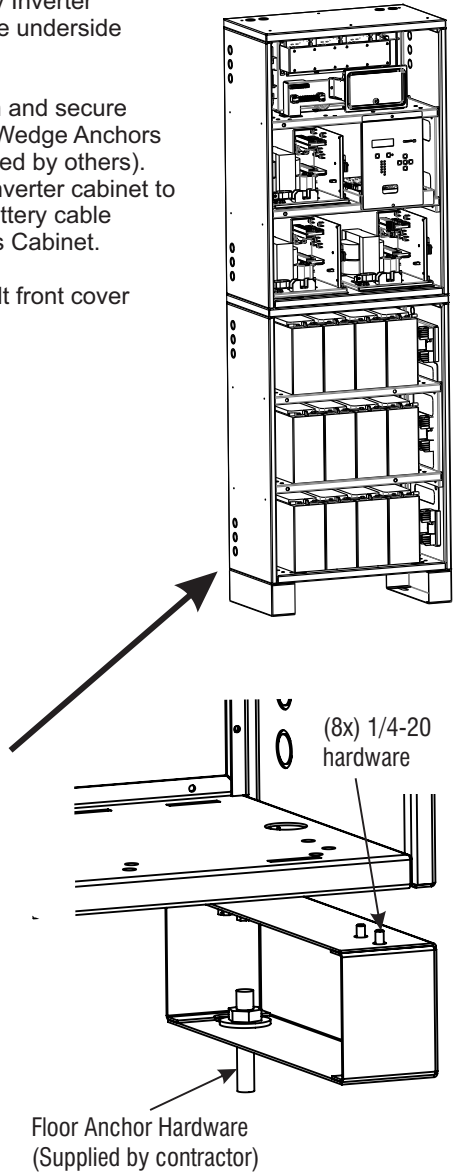
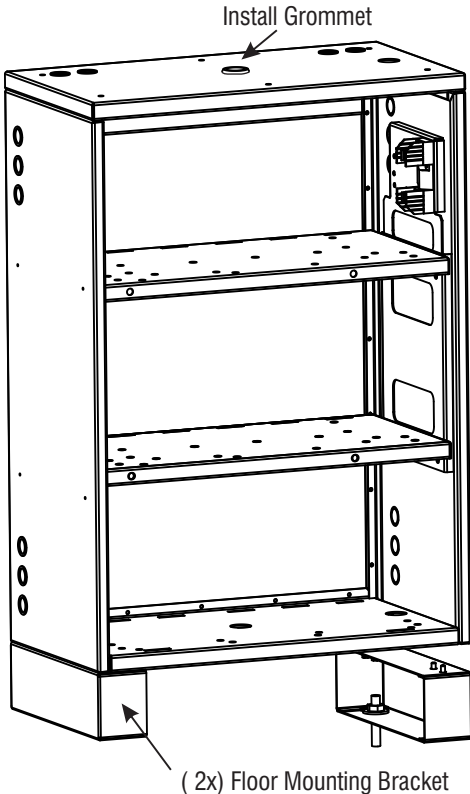

*Install Grommet in Battery Cabinet for wire protection before stacking the cabinets.

Secure Inverter cabinet on top of Battery Cabinet with 6 x 1/4-20 bolts (factory provided).

Bolts are mounted from the underside of the Battery Cabinet and screw up into PEM® fasteners in the bottom of the Inverter Cabinet.

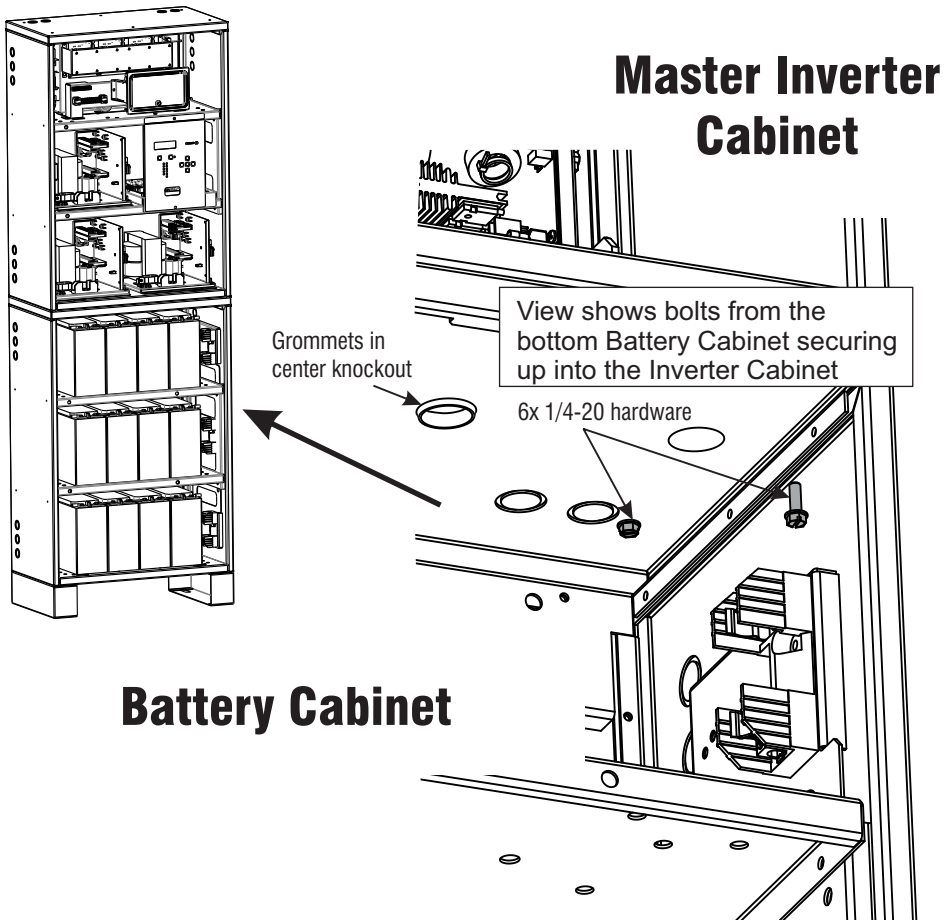

Step 2 Installing and Wiring the Batteries

Note – Always ensure that all 3 of the DC Fuses in the battery cabinet are removed before starting installation. Battery cable lengths are sufficient for Vertical or Side by Side mounting. Positive and Negative battery cables should be trimmed to length when using Vertical (Stacked) configuration before installing into the battery cabinets terminal blocks. This system has a Series/Parallel battery arrangement. Four batteries are wired in series on each shelf to produce 48VDC. Each 48VDC battery shelf is wired together so that there are 3 battery shelves (strings) in parallel. Please see wiring schematic in the manual and on the battery cabinet door for further explanation.

1. Route Red and Black wires from Inverter Cabinet to Battery Cabinet. Connect Red and Black wires to the top side of the Positive and Negative Terminal Blocks respectively. Positive +48VDC Red cable is the front Terminal Block, Negative DC Black cable is the Rear Terminal Block. When using the Vertical Stacked configuration, the DC wires have to be run between the two inverter modules on the bottom shelf of the Inverter Cabinet.
2. Load all 12 batteries onto the battery shelves. Ensure proper spacing between batteries so that Battery-Battery Buss Bar Jumpers can be installed properly in Step 4 below.
3. Connect all Positive battery cables on each shelf to the right battery on each shelf.
4. Connect all Battery Buss Bars between adjacent batteries on each shelf.
5. Connect all Negative battery cables on each shelf to the left battery on each shelf.
6. Measure and ensure correct DC string voltage (48VDC) and ensure all connections are made.
7. Install all 3 Fuses.

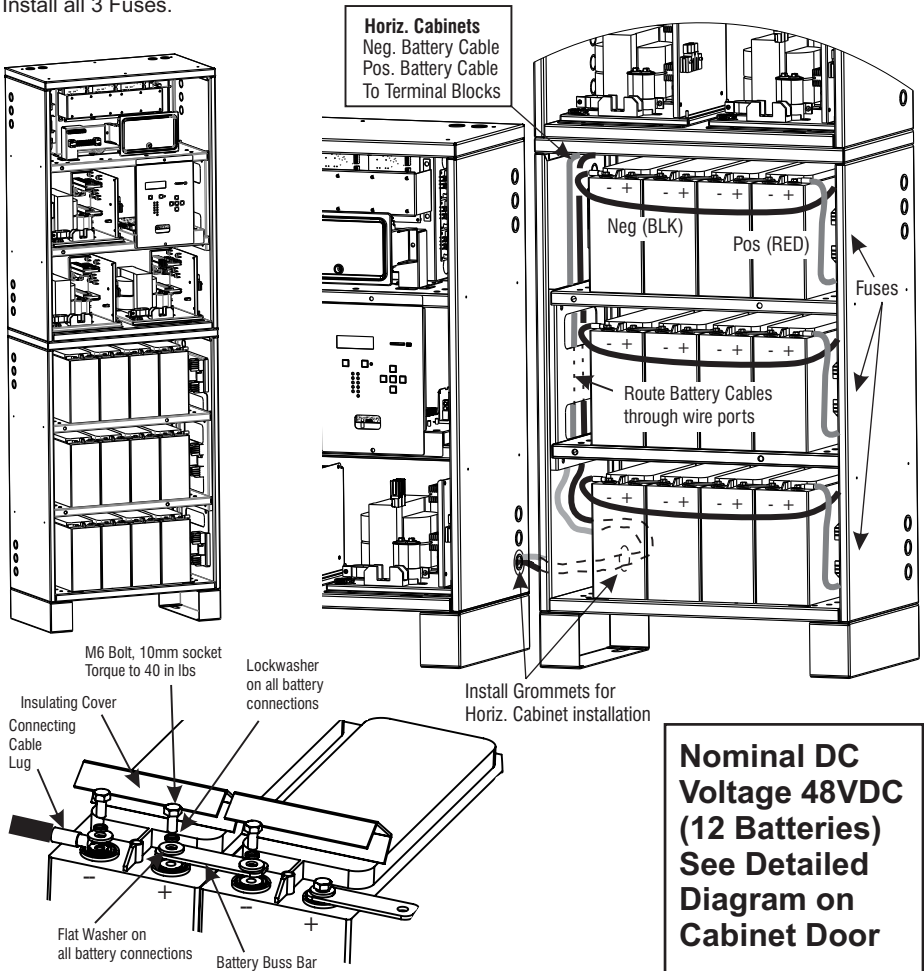

Step 3 Installing the AC Conduit

Use Provided Knock-Outs located on Tops and Sides of Inverter Cabinet

Note – Drilling into cabinets may VOID warrant - metal shavings can short circuit electronic components.

Input and Output Wires should be run in separate conduit per NEC.

Knock-Outs are a dual size for 7/8" and 1-1/8".
Follow all Local and National Electrical Codes (NEC)

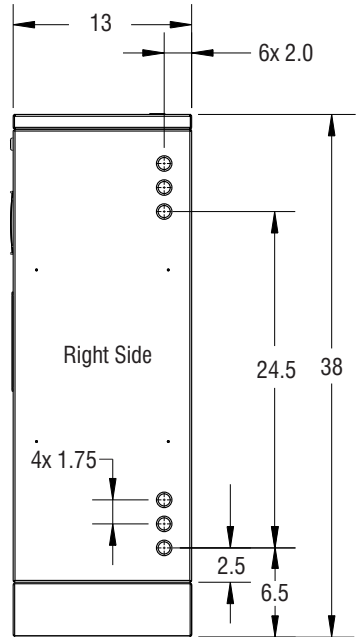
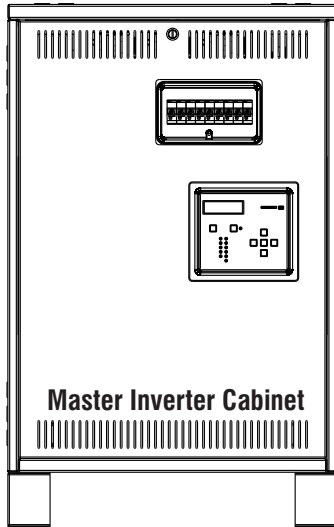
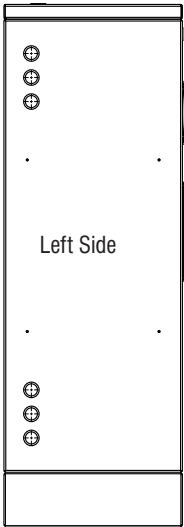
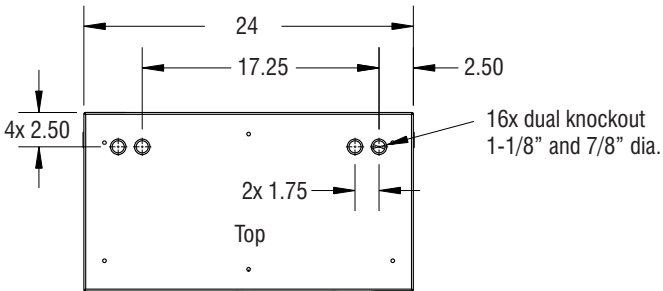

Knockout pattern identical to right side

Step 4 Installing the AC Wiring

Ensure the AC Input Breaker CB1 is in the OFF (Down) position before starting. See Installation/Operating manual (section 7) for AC Input and Output AC ratings. Remove Plastic AC Circuit Breaker Cover (secured with 2 x 1/4-20 bolts). Wire AC input directly to top side of Input Breaker - AC Input Circuit Breaker on Left side.

Wire Input Neutral and Ground connections to appropriate Neutral and Ground Bars. Do not share Neutrals with Emergency and Non-Emergency loads. Connect AC output wires to the top side of Normally-On terminal block or output circuit breakers if provided. Standard equipment always has a Normally-On output terminal block for output wire connections. AC Output Breakers are Optional. Follow all Local and National Electrical Codes (NEC)

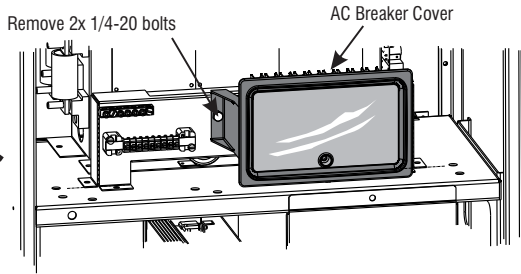
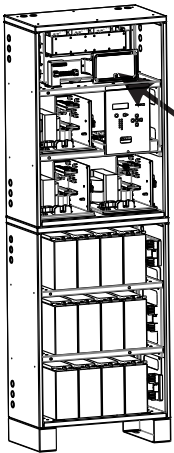

Standard Output Terminal Block Illustration

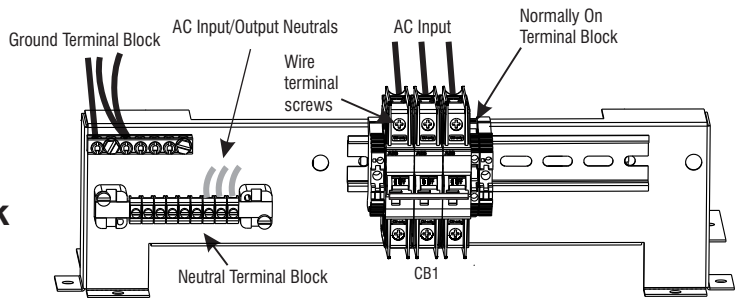

Optional Output Circuit Breaker Illustration

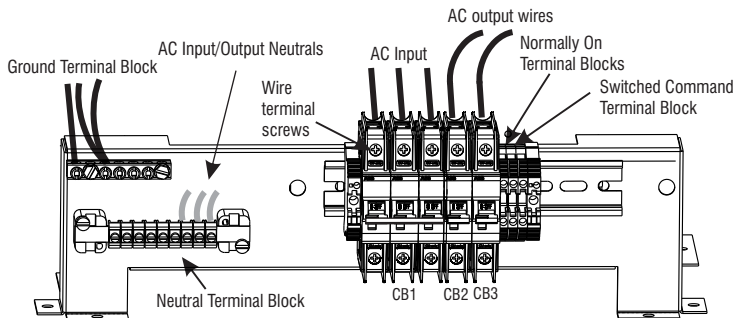

Step 5 Starting Up/Energizing the Unit

Ensure batteries are installed, the wiring is checked per Step 2.

Ensure AC Power is present and lighting loads are connected per Step 4.

Flip on Input Circuit Breaker CB1.

Flip on System's On/Off Switch located to the right of the Interface Panel.

System will go through start up diagnostics and go into charge mode if there are no errors.

Press the system test button or momentarily drop AC power to energize emergency power and ensure that the inverter can support the lighting loads without going into a fault condition.

Replace and secure AC Breaker Cover and its clear access window with locking screw.

Install front cover to Cabinets.

Contents of shipment

3KW Model include:

Cabinets – 3KW models use two cabinets.

Floor Mounting Brackets – Attached to Battery Cabinet and Inverter Cabinet.

Batteries –12 pieces for 3KW

Battery Cable Kit – All Models

Cabinet Hardware Kit – All Models except 1KW

Installation/Operation Manual – All Models

Contractors Guide – All Models

Tools Required for Installation (typical all models)

3/8" Nut Driver and/or 3/8" Socket and Ratchet

Straight Blade Screwdriver(s)

Square Head (Robertson) Screwdriver

Phillips Head Screwdriver - #2

10MM Socket and Ratchet – or – 10MM Wrench (Torque set to 30 in-lbs.)

3/16 Allen Head (Only for Side By Side mounting – Battery Cable Replacement)

Hardware for securing cabinet to floor – i.e. Hilti Kwik Bolt or equivalent Multi-Meter capable of DC and AC Measurements